

Diâmetro do tubo - Ø	A	B	C	D	E	L
20cm	80cm	80cm	20cm	20cm	10cm	134cm
30cm	80cm	80cm	30cm	30cm	10cm	146cm
40cm	90cm	90cm	40cm	40cm	10cm	158cm
60cm	120cm	120cm	60cm	60cm	10cm	182cm
80cm	140cm	140cm	80cm	80cm	35cm	231cm
100cm	160cm	160cm	100cm	100cm	40cm	260cm
120cm	184cm	184cm	120cm	120cm	42cm	286cm
150cm	380cm	220cm	150cm	150cm	50cm	330cm
200cm	420cm	280cm	200cm	200cm	55cm	395cm

BOCA DE LOBO

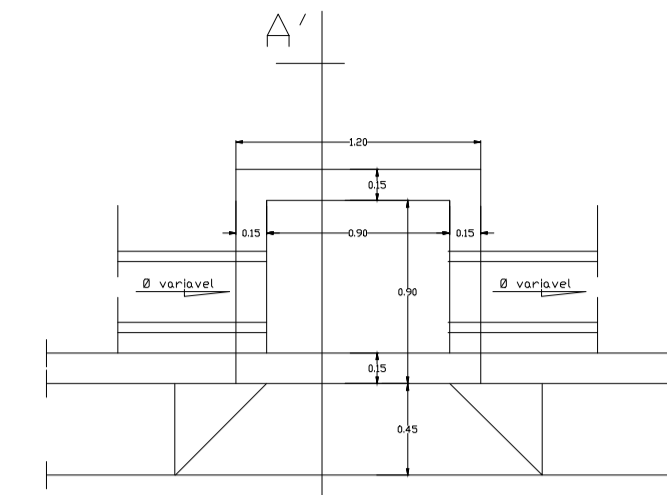

DETALHE

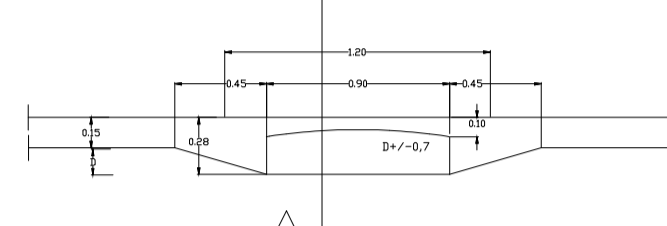

CORTE "B"

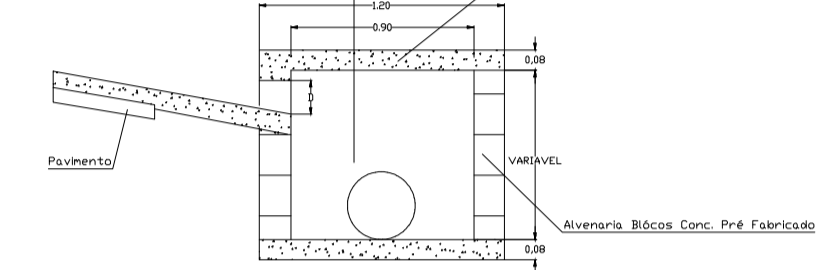

CORTE "A"

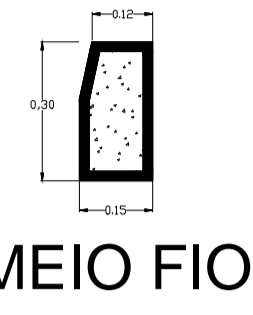

MEIO FIO

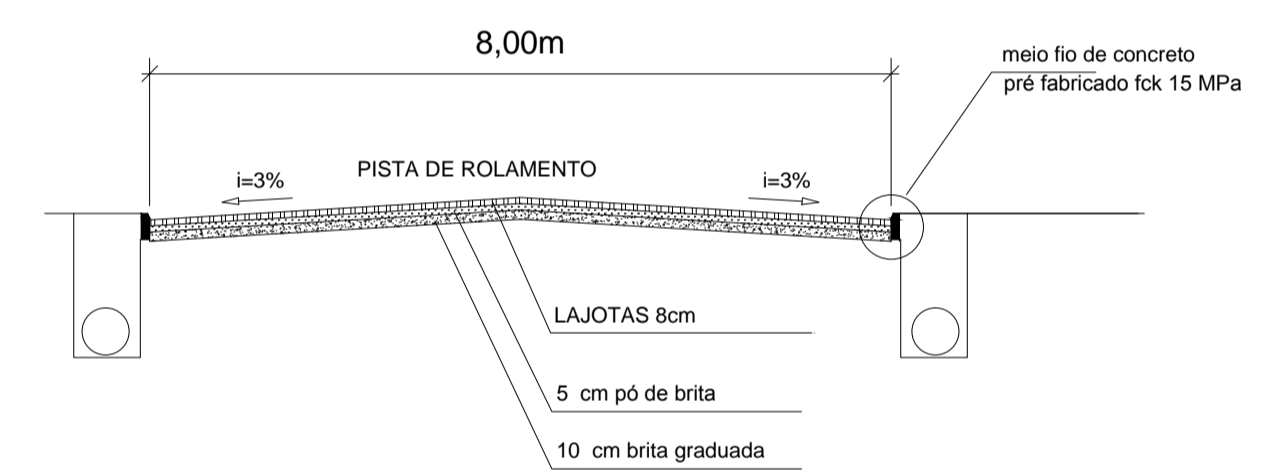
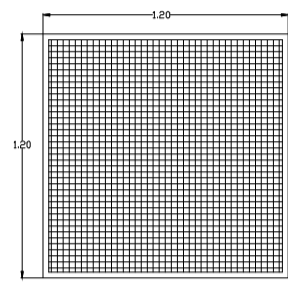
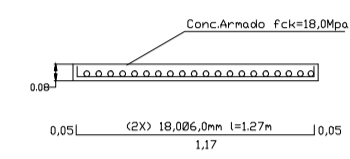

SEÇÃO TRANSVERSAL s/esc

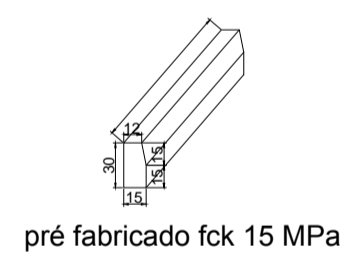

PROJETO:
PROJETO PAVIMENTAÇÃO LAJOTA SEXTAVADA RUA JOSÉ F. DA SILVA

RESP. TÉCNICO: WILLIAN Fritzen Branco ENGENHEIRO CIVIL
PROPRIETÁRIO: PREFEITURA MUNICIPAL DE CERRO NEGRO

LOCAL: CERRO NEGRO
DATA: JANEIRO 2022
PRANCHA: ÚNICA

PROPRIETÁRIO: PREFEITURA MUNICIPAL DE CERRO NEGRO

OBRA: PROJETO DE PAVIMENTAÇÃO EM LAJOTAS RUA JOSÉ F. DA SILVA
DESENHO: GILMAR

DISCRIMINAÇÃO: PROJETO PAVIMENTAÇÃO
ÁREA: 1.016,00 m2